

29786 MAHOGANY PI COAT STAND - WITH SHELF ASSEMBLY INSTRUCTIONS FOR COAT STAND

HARDWARE & TOOL ENCLOSED

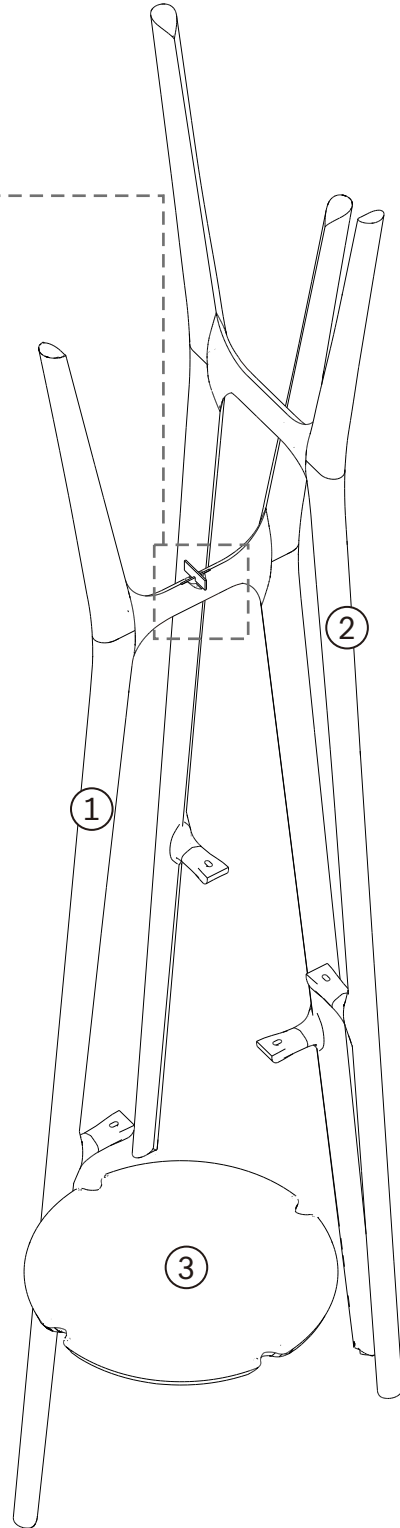
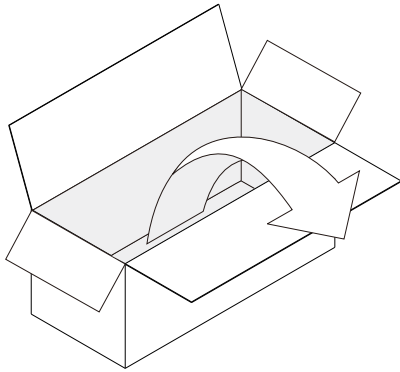
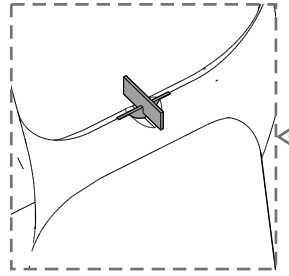
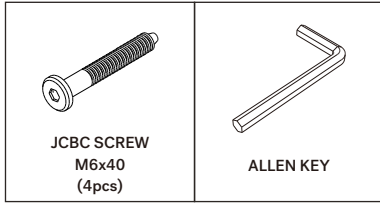

IN YOUR PACKAGE :

ASSEMBLY INSTRUCTIONS
HARDWARE (AS LISTED ABOVE)

PARTS TO BE INSTALLED

1. LEG 1 (1 pc) -> WITH METAL PLATE INSTALLED
2. LEG 2 (1 pc)
3. SHELF (1 pc)

SYMBOLS



DIRECTION

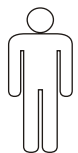

NUMBER OF
PERSONS NEEDED



USE HAND

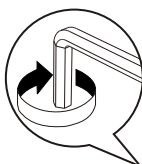

USE ALLEN KEY
TO TIGHTEN

NOTICE

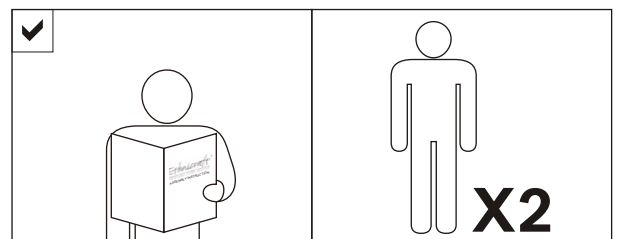

29786 MAHOGANY PI COAT STAND - WITH SHELF ASSEMBLY INSTRUCTIONS FOR COAT STAND

A ATTACHING LEGS

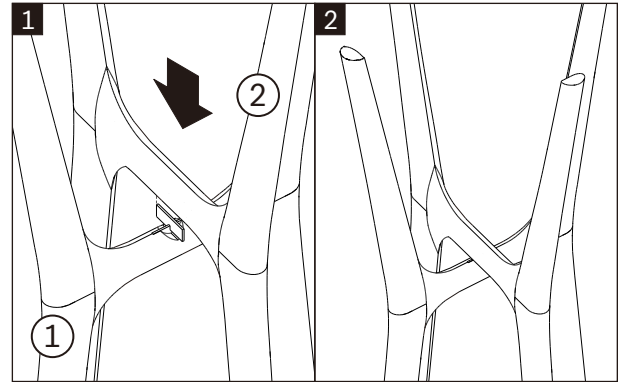
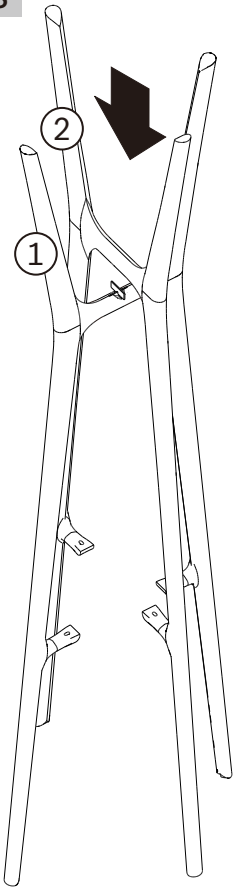

 **MAKE SURE THE METAL PLATE GOES INTO THE GROOVES ON THE LEG (2)**

B ATTACHING SHELF

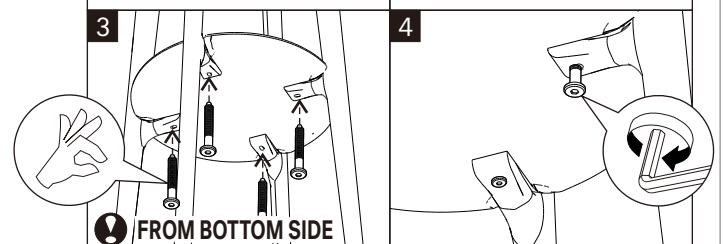
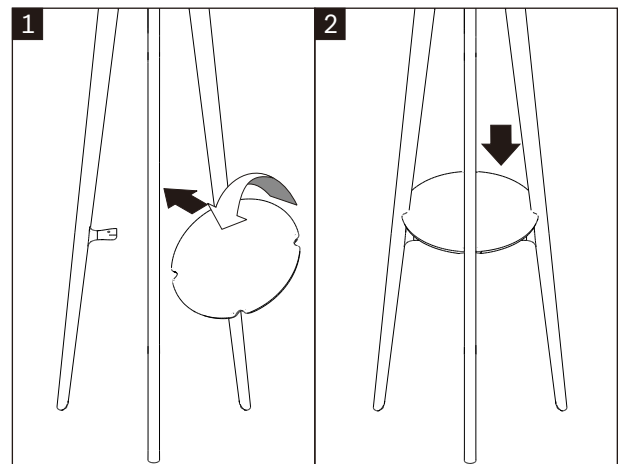
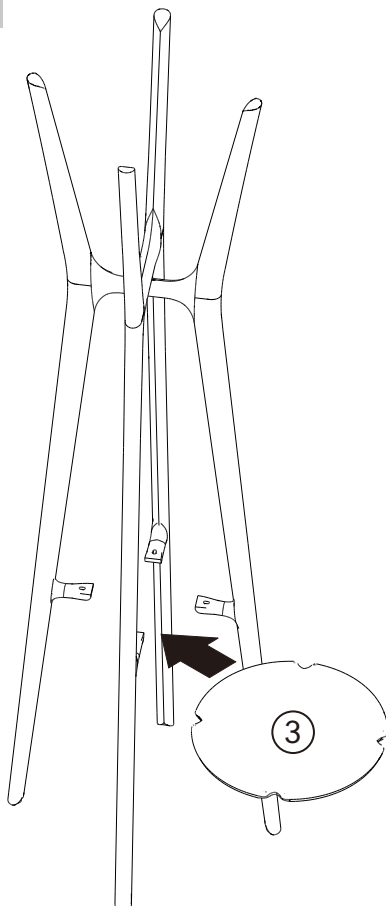

 **FROM BOTTOM SIDE**

 **- USE JCBC SCREW M6x40 (4X)
- TIGHTEN FULLY**