

# SARAH ELLISON.



## KHOUIE PLANTERS

### Assembly

No assembly required.

### Warranty

We offer a 1 year homewares product warranty against defects. This does not cover general wear and tear, or accidental breakage post-delivery.

### Construction

Polyresin, Stone & Powder, Colour Pigment & Fiberglass

### Small Planter Dimensions W x D x H (cm)

Overall: 42 x 42 x 35 cm  
Weight: 7.5 kg

Number of Cartons : 1  
Carton Content: Planter

Carton 1: 53 x 53 x 53cm | 10kg

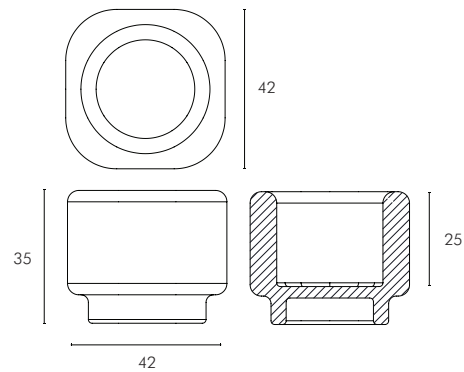

### Medium Planter Dimensions W x D x H (cm)

Overall: 55 x 55 x 45cm  
Weight: 11 kg

Number of Cartons : 1  
Carton Content: Planter

Carton 1: 66 x 66 x 68cm | 40kg

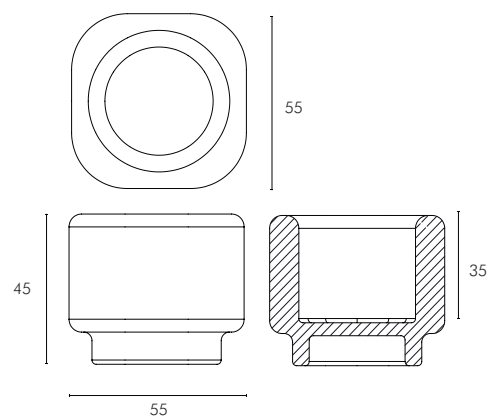

Please note all dimensions are approximate.

# SARAH ELLISON.

## KHOUIE PLANTERS

---

### Large Planter Dimensions W x D x H (cm)

Overall: 50 x 50 x 70 cm

Weight: 15.5 kg

Number of Cartons : 1

Carton Content: Planter

Carton 1: 66 x 66 x 68cm | 18kg

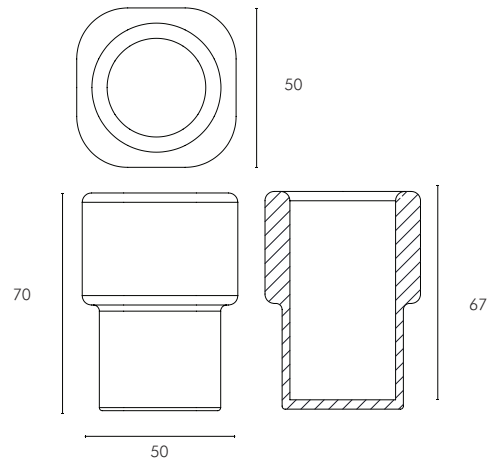

Please note all dimensions are approximate.