

Ethnicraft

ASSEMBLY INSTRUCTION FOR ANTI-TIPPING INSTALLATION

HARDWARE ENCLOSED

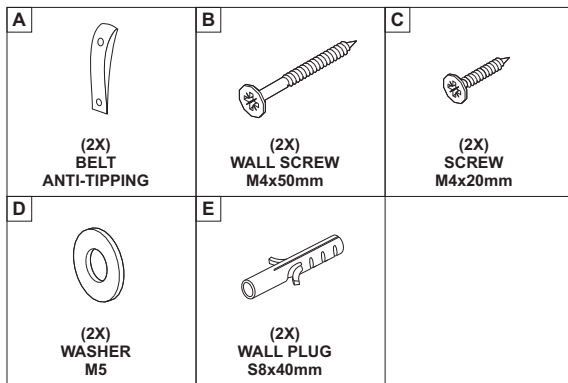

TOOLS

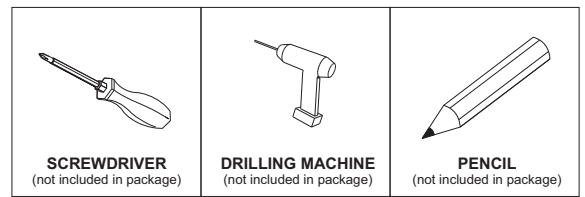

INSTALLING ANTI-TIPPING SYSTEM



AS WALL MATERIALS VARY,
THE SCREW INCLUDED ARE FOR BRICK WALL.
FOR ADVICE ON SUITABLE SCREW SYSTEMS,
CONTACT YOUR LOCAL SPECIALISED DEALER.

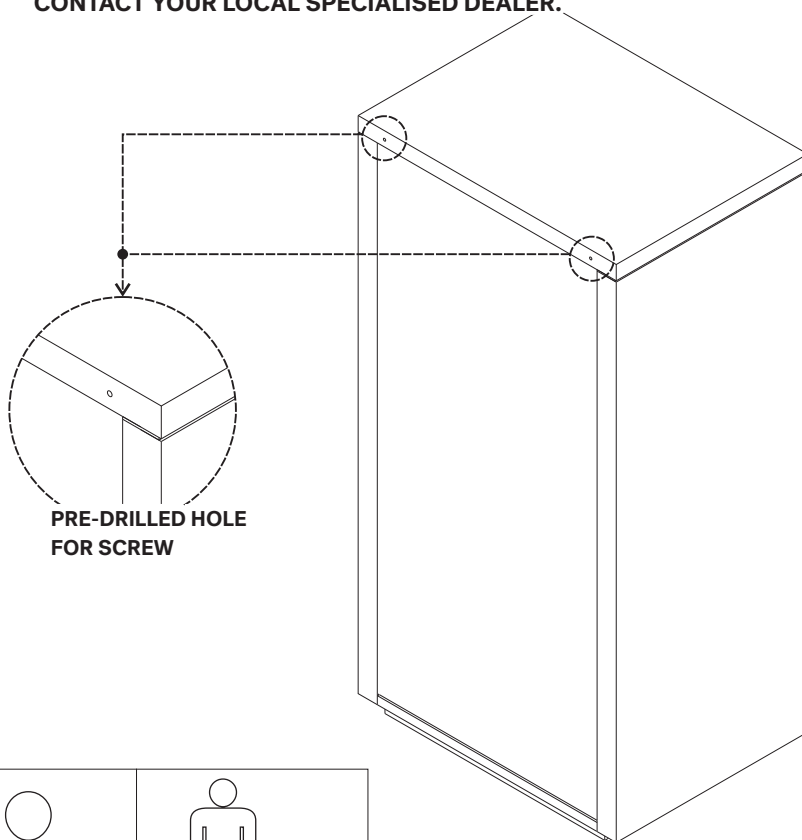

NOTICE

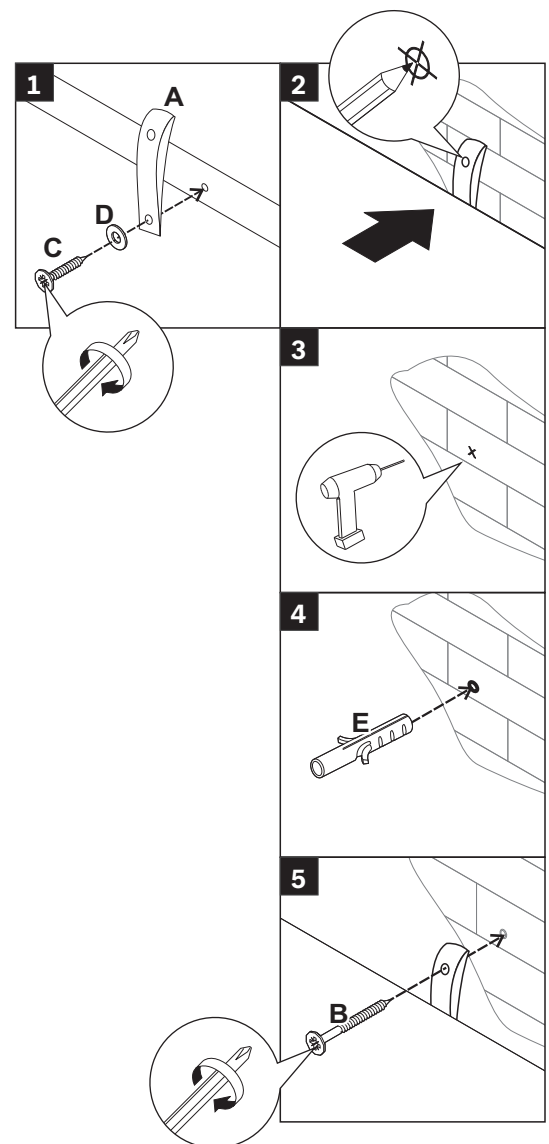
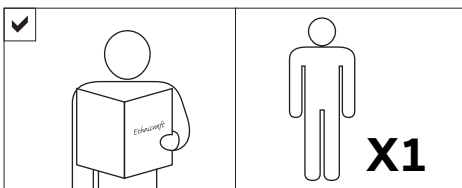

INSTRUCTION

1. Install anti-tipping belt (A), washer (D) with M4x20mm screw (C) into the pre-drilled hole on the top back frame of the item.
2. Using a 1/4" diameter drill bit, drill the wall at the same level as the anti-tipping belt (A) on the item. Install the wall plug (E) into the hole.
3. Connect the anti-tipping belt (A) with wall screw (B) into the wall plug (E)